

Varenummer: 207321M101212NI  
Beskrivelse: E+G Pasbolt  
GN 732.1-M10-12-12-NI

## Mål

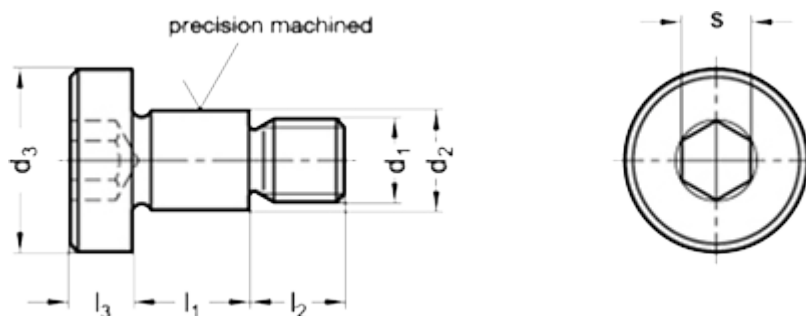

### Application example



d1	= M 10
d2	= 12 -0.05/-0.08
d3	= 19
$l_1 +0.20/+0.13$	= 12
$l_2$	= 13
$l_3$	= 6
s	= 6
Vægt i (g)	= 18